

APPROX VALVE WEIGHT	
CI+ST STL 120Kg : AL ALLOY 60Kg	
ORDER No.	
JOB No.	J
CERTIFIED	

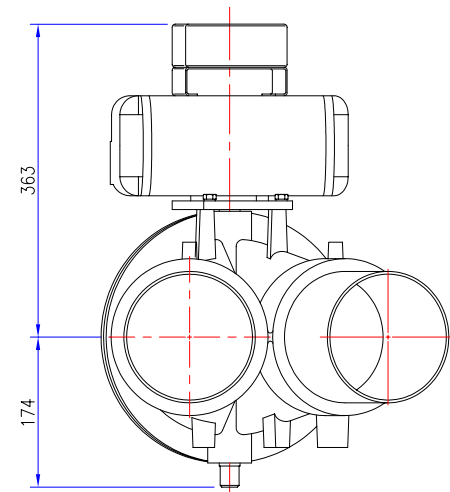
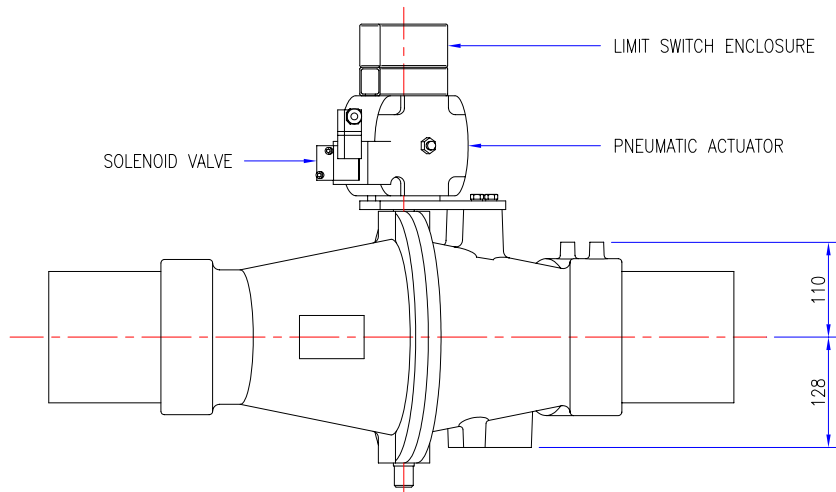

A	ORIGINAL
	REVISIONS

TOLERANCES	UP TO VALVE SIZE	VALVE SIZE & OVER
FACE-FACE	250 ±1.5	300 ±3
FLANGE THK.	450 ±3	500 ±5
PIPE O/D	100 ±1.5	115 ±2
OTHER	450 ±6	500 ±8

PROJECTION	
SCALE :	1:3 (A1)
DIMENSIONS IN mm	
©ROTA VAL	

ROTAVAL

CHIPPENHAM WILTS

DRN	CHKD	APPD	DATE
J.PORTER	SC	D.C.S	18-10-02

TITLE		FDPA150 DIVERTER VALVE	
		LEFT HAND DIVERT PLANNING IN DIMENSIONS	
JOB No.	DRG No.	SHEET	ISSUE
	FDPA-150-LHD	1	A